

07

STORA-DRAIN

BASE

B125 / C250



POLYESTER CONCRETE DRAINAGE CHANNEL WITH 2MM GALVANIZED PROFILE

STORA-DRAIN
BASE 100
 CHANNEL + GRATING

B125



- anchorage screw
- galvanized mesh grating 30x10

C250



- anchorage screw
- galvanized mesh grating 30x10

C250

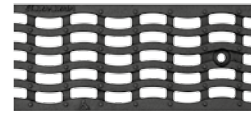

- anchorage screw
- ductile iron grating "WAVE"

B=100, C=132 D=140	H	Vertical outlet	Article number	Retail price Eur/pcs.	Article number	Retail price Eur/pcs.	Article number	Retail price Eur/pcs.
channel 1,0m	80	Ø 110	SB10081223	on request	SB10081225	on request	SB10081352	77,00
channel 0,5m standard	80	Ø 110	SB10085224	on request	SB10085226	on request	SB10085352	53,00
channel 1,0m	100	Ø 110	SB10101223	on request	SB10101225	on request	SB10101352	77,00
channel 0,5m standard	100	Ø 110	SB10105224	on request	SB10105226	on request	SB10105352	53,00
channel 1,0m	150	Ø 110	SB10151223	on request	SB10151225	on request	SB10151352	85,00
channel 0,5m standard	150	Ø 110	SB10155224	on request	SB10155226	on request	SB10155352	59,00
channel 1,0m	200	Ø 110	SB10201223	on request	SB10201225	on request	SB10201352	97,00
channel 0,5m standard	200	Ø 110	SB10205224	on request	SB10205226	on request	SB10205352	67,00
channel 1,0m	250	Ø 110	SB10251223	on request	SB10251225	on request	SB10251352	108,00
channel 0,5m standard	250	Ø 110	SB10255224	on request	SB10255226	on request	SB10255352	76,00

B125



- One part sump unit + bucket + galvanized mesh grating 30x10

C250

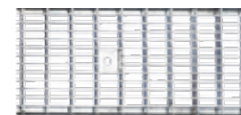

- One part sump unit + bucket + galvanized mesh grating 30x10

C250

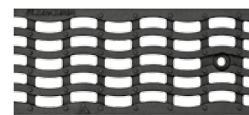

- One part sump unit + bucket + iron grating "WAVE"

SUMP UNIT 100

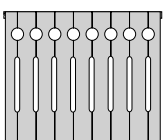
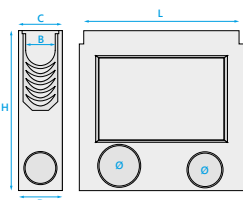

L	500		500		500	
H	370	470	370	470	370	470
Outlet front/side	Ø 110		Ø 110		Ø 110	
Article number	AU11901224 do H=100-150	AU11911224 do H=100-250	AU11901226 do H=100-150	AU11911226 do H=100-250	AU11901352 do H=80-150	AU11911352 do H=100-250
Retail price Eur/pcs.	on request	on request	on request	on request	142,00	165,00

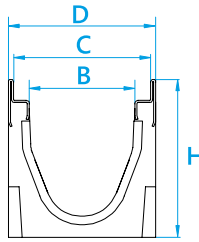

STORA-DRAIN
i **BASE 150**
CHANNEL + GRATING

C250



- anchorage screw
- galvanized mesh grating 30x10

C250

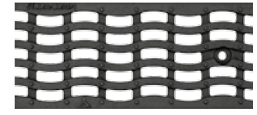

- anchorage screw
- ductile iron grating "WAVE"

B=150 C=182 D=190	H	Vertical outlet	Article number	Retail price Eur/pcs.	Article number	Retail price Eur/pcs.
channel 1,0m	120	Ø 160	SB15121229	on request	SB15121353	116,00
channel 0,5m standard	120	Ø 160	SB15125230	on request	SB15125353	81,00
channel 1,0m	195	Ø 160	SB15191229	on request	SB15191353	134,00
channel 0,5m standard	195	Ø 160	SB15195230	on request	SB15195353	93,00
channel 1,0m	245	Ø 160	SB15241229	on request	SB15241353	144,00
channel 0,5m standard	245	Ø 160	SB15245230	on request	SB15245353	101,00

i All dimensions **B, C, D, H** are in **mm**, half of quantity on one pallet are with possibility to make vertical outlet.

SUMP UNIT
150

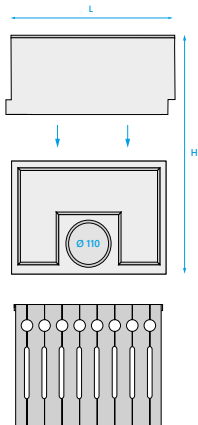

C250

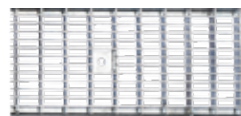

- Two parts sump unit + bucket + galvanized mesh grating 30x10

C250

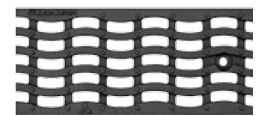

- Two parts sump unit + bucket + iron grating "WAVE"

L	500	500	500	500
H	665	270	665	270
Outlet front/side	Ø 110/160	Ø 110	Ø 110/160	Ø 110
Article number	AU10411230*	AU11921230**	AU10411353*	AU11921353**
Retail price Eur/pcs.	on request	on request	272,00	160,00

- * 2-parts sump unit for channels H=245 - H=295
- ** 1-part sump unit for channel H=120

BASE

STORA-DRAIN
BASE 200
 CHANNEL + GRATING

C250

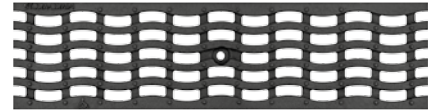

- anchorage screw
- ductile iron grating "WAVE"

B=200 C=232 D=240	H	Vertical outlet	Article number	Retail price Eur/pcs.
channel 1,0m	120	Ø 200	SB20212354	153,00
channel 0,5m	120	Ø 200	SB20125354	107,00
channel 1,0m	245	Ø 200	SB20241354	181,00
channel 0,5m	245	Ø 200	SB20245354	127,00
channel 1,0m	295	Ø 200	SB20291354	197,00
channel 0,5m	295	Ø 200	SB20295354	138,00

SUMP UNIT
200

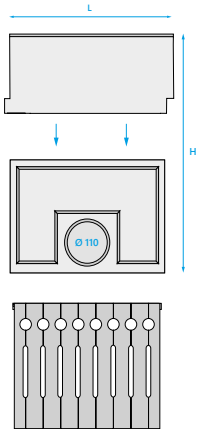

C250

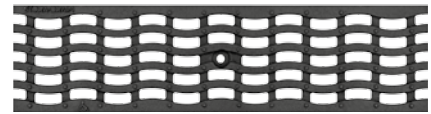

- Two parts sump unit + bucket + iron grating "WAVE"

L	500	500
H	700	270
Outlet front/side	Ø 160/200	Ø 110
Article number	AU10411354 *	AU11931354 * *
Retail price Eur/pcs.	308,00	185,00

- * 2-parts sump unit match to the channels H=245 - H=295
- * * 1-part sump unit match to the channel H=120

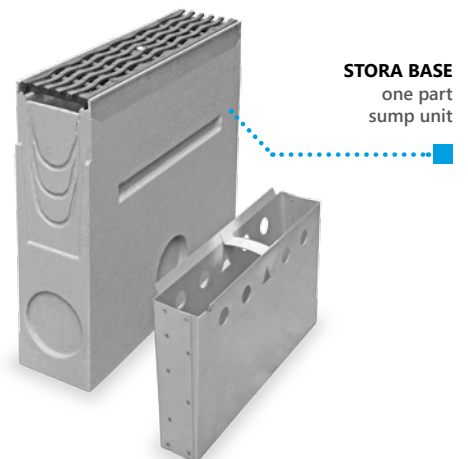
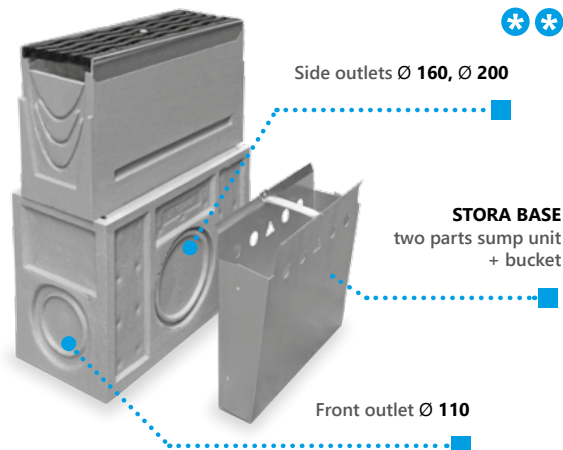

i STORA-DRAIN
BASE 300
 CHANNEL + GRATING

C250

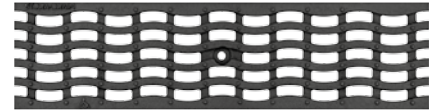

- anchorage screw
- ductile iron grating "WAVE"

B=300 C=332 D=340	H	Vertical outlet	Article number	Retail price Eur/pcs.
channel 1,0m	295	Ø 200	SB30291355	291,00
channel 0,5m standard	295	Ø 200	SB30295355	203,00

SUMP UNIT 300

C250

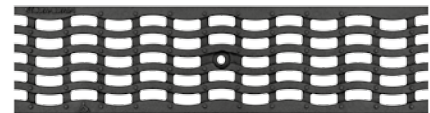

- Two parts sump unit + bucket + iron grating "WAVE"

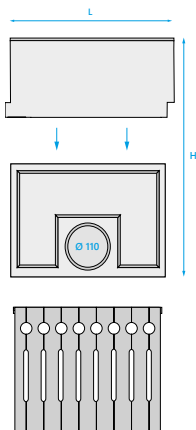

L	500
H	645
Outlet front/side	Ø 110/160/200
Article number	AU10601355
Retail price Eur/pcs.	344,00

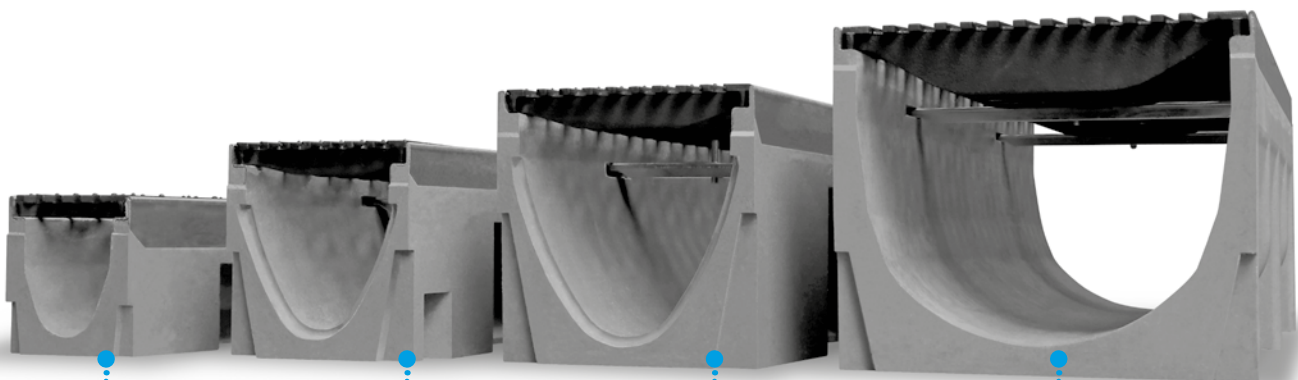

BASE 100

BASE 150

BASE 200

BASE 300

ENDCAPS 100/150/200/300

Typ	H	Outlet	Article number	Retail price Eur/pcs.
100	80	closed	AE10099000	20,00
100	100	closed	AE10079000	20,00
100	100	with pipe Ø 110	AE10089000	28,00
100	150	closed	AE10019000	20,00
100	150	with pipe Ø 110	AE10029000	28,00
100	200	closed	AE10039000	20,00
100	200	with pipe Ø 110	AE10049000	28,00
100	250	closed	AE10059000	20,00
100	250	with pipe Ø 110	AE10069000	28,00
150	120	closed	AE15029000	20,00
150	195	Ø 110 universal	AE15009000	28,00
150	245	Ø 110 universal	AE15019000	28,00
200	120	closed	AE20019000	20,00
200	245	Ø 160 universal	AE20009000	31,00
200	295	Ø 160 universal	AE20029000	31,00
300	295	Ø 200 universal	AE30008000	53,00



Closed

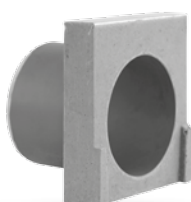

with pipe

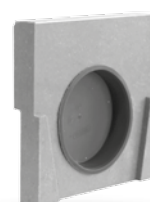

Universal

STEPPED FALL 100/150

Type	For channel (H)	Article number	Retail price Eur/pcs.
100	H 150/200/250	AL10000102	15,00
150	H 195/245	AL15000102	20,00
200	H 245/295	AL20000102	26,00



SEALANT

Type	Color	Capacity	Article number	Retail price Eur/pcs.
Sealant to connect elements from polyester concrete	grey	310 ml	PUP0000310	15,00

