

# 07

STORA-DRAIN

## BASE

B125 / C250



POLYESTER CONCRETE DRAINAGE CHANNEL WITH 2MM GALVANIZED PROFILE

STORA-DRAIN  
**BASE** 100  
 CHANNEL + GRATING

**B125**

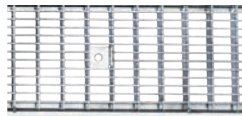

- anchorage screw
- galvanized mesh grating 30x10

**C250**

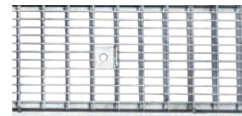

- anchorage screw
- galvanized mesh grating 30x10

**C250**

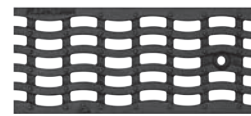

- anchorage screw
- ductile iron grating "WAVE"

B=100, C=132 D=140	H	Vertical outlet	Article number	Retail price Eur/pcs.	Article number	Retail price Eur/pcs.	Article number	Retail price Eur/pcs.
channel 1,0m	100	Ø 110	SB10101223	on request	SB10101225	on request	SB10101352	77,00
channel 0,5m standard	100	Ø 110	SB10105224	on request	SB10105226	on request	SB10105352	53,00
channel 1,0m	150	Ø 110	SB10151223	on request	SB10151225	on request	SB10151352	85,00
channel 0,5m standard	150	Ø 110	SB10155224	on request	SB10155226	on request	SB10155352	59,00
channel 1,0m	200	Ø 110	SB10201223	on request	SB10201225	on request	SB10201352	97,00
channel 0,5m standard	200	Ø 110	SB10205224	on request	SB10205226	on request	SB10205352	67,00
channel 1,0m	250	Ø 110	SB10251223	on request	SB10251225	on request	SB10251352	108,00
channel 0,5m standard	250	Ø 110	SB10255224	on request	SB10255226	on request	SB10255352	76,00

**B125**



- One part sump unit + bucket + galvanized mesh grating 30x10

**C250**



- One part sump unit + bucket + galvanized mesh grating 30x10

**C250**

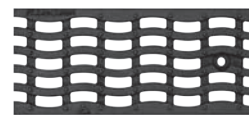

- One part sump unit + bucket + iron grating "WAVE"

## EINLAUFKASTEN 100

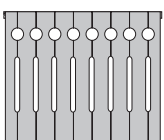
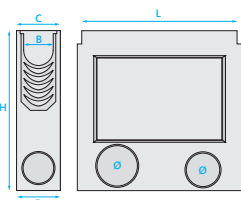

L	500		500		500	
H	370	470	370	470	370	470
Outlet front/side	Ø 110		Ø 110		Ø 110	
Article number	AU11901224 do H=100-150	AU11911224 do H=100-250	AU11901226 do H=100-150	AU11911226 do H=100-250	AU11901352 do H=100-150	AU11911352 do H=100-250
Retail price Eur/pcs.	on request	on request	on request	on request	142,00	165,00

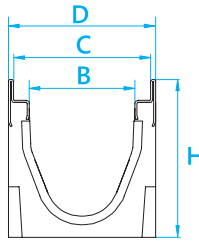

**STORA-DRAIN**  
**i** **BASE 150**  
**CHANNEL + GRATING**

**C250**

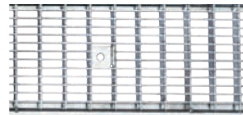

- anchorage screw
- galvanized mesh grating 30x10

**C250**

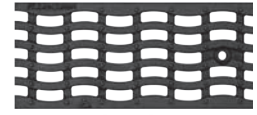

- anchorage screw
- ductile iron grating "WAVE"

B=150 C=182 D=190	H	Vertical outlet	Article number	Retail price Eur/pcs.	Article number	Retail price Eur/pcs.
channel 1,0m	195	Ø 160	SB15191229	<b>on request</b>	SB15191353	<b>134,00</b>
channel 0,5m standard	195	Ø 160	SB15195230	<b>on request</b>	SB15195353	<b>93,00</b>
channel 1,0m	245	Ø 160	SB15241229	<b>on request</b>	SB15241353	<b>144,00</b>
channel 0,5m standard	245	Ø 160	SB15245230	<b>on request</b>	SB15245353	<b>101,00</b>

**i** All dimensions **B, C, D, H** are in **mm**, half of quantity on one pallet are with possibility to make vertical outlet.

**EINLAUFKASTEN**  
**150**

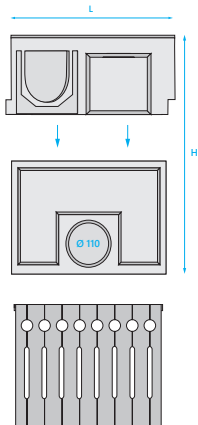

**C250**



- Two parts sump unit + bucket + galvanized mesh grating 30x10

**C250**

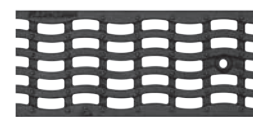

- Two parts sump unit + bucket + iron grating "WAVE"

<b>L</b>	500	500
<b>H</b>	650	650
<b>Outlet front/side</b>	Ø 110/160/200	Ø 110/160/200
<b>Article number</b>	AU10411230	AU10411353
<b>Retail price Eur/pcs.</b>	<b>on request</b>	<b>272,00</b>

**STORA-DRAIN**  
**BASE 200**  
 CHANNEL + GRATING

**C250**

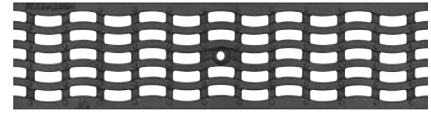

- anchorage screw
- ductile iron grating "WAVE"

B=200 C=232 D=240	H	Vertical outlet	Article number	Retail price Eur/pcs.
channel 1,0m	245	Ø 200	SB20241354	<b>181,00</b>
channel 0,5m standard	245	Ø 200	SB20245354	<b>127,00</b>

**EINLAUFKASTEN**  
**200**

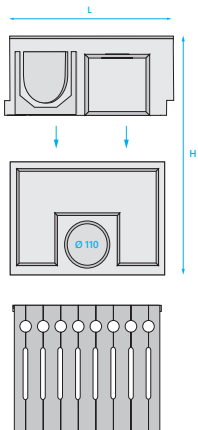

**C250**

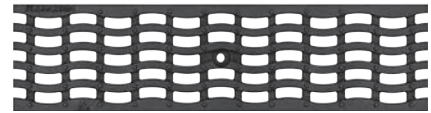

- Two parts sump unit + bucket + iron grating "WAVE"

<b>L</b>	500
<b>H</b>	650
<b>Outlet front/side</b>	Ø 110/160/200
<b>Article number</b>	AU10411354
<b>Retail price Eur/pcs.</b>	<b>308,00</b>

**BASE**

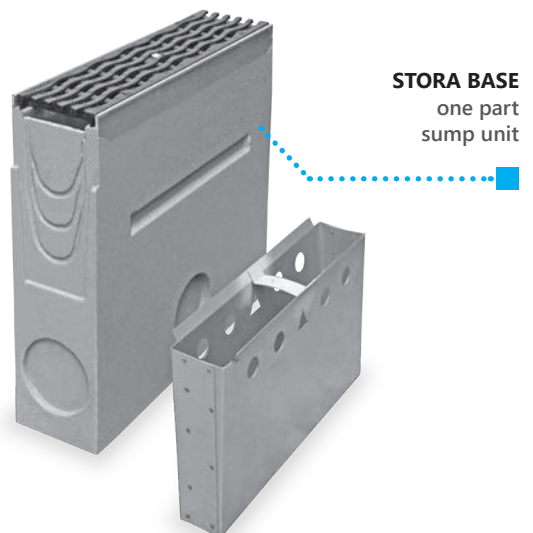
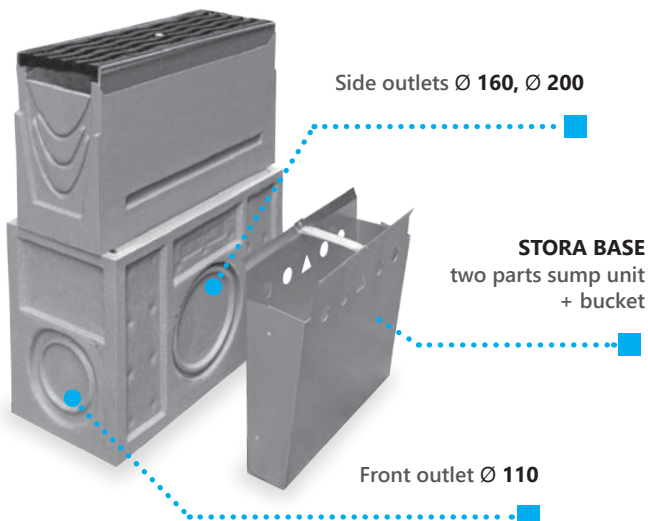

**STORA-DRAIN**  
**BASE 300**  
 CHANNEL + GRATING

C250

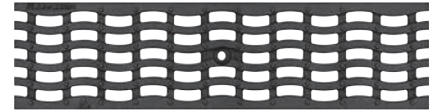

- anchorage screw
- ductile iron grating "WAVE"

B=300 C=332 D=340	H	Vertical outlet	Article number	Retail price Eur/pcs.
channel 1,0m	295	Ø 200	SB30291355	<b>291,00</b>
channel 0,5m standard	295	Ø 200	SB30295355	<b>203,00</b>

**EINLAUFKASTEN**  
**300**

C250



- Two parts sump unit + bucket + iron grating "WAVE"

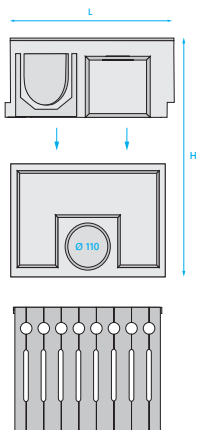

L	500
H	700
Outlet front/side	Ø 110/160/200
Article number	AU10601355
Retail price Eur/pcs.	<b>344,00</b>

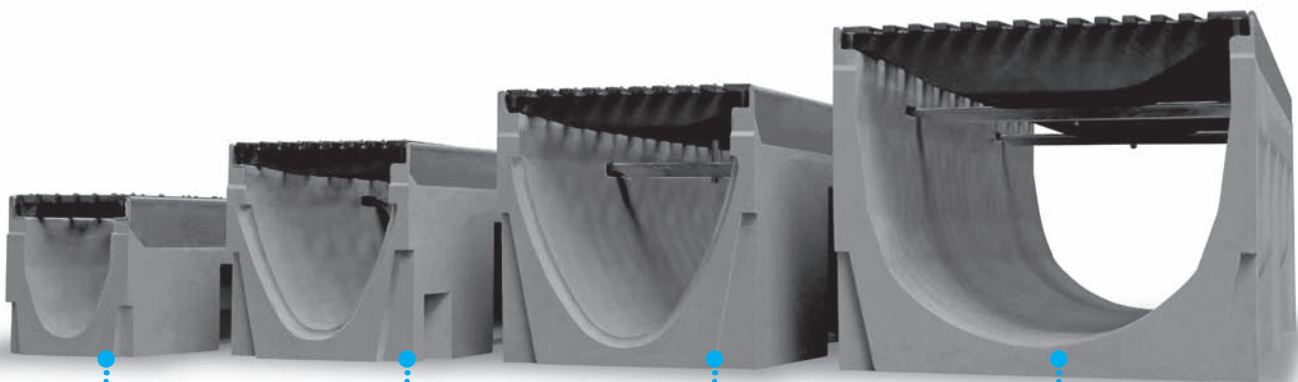

BASE 100

BASE 150

BASE 200

BASE 300

## ENDCAPS 100/150/200/300

Typ	H	Outlet	Article number	Retail price Eur/pcs.
100	100	closed	AE10079000	<b>20,00</b>
100	100	with pipe Ø 110	AE10089000	<b>28,00</b>
100	150	closed	AE10019000	<b>20,00</b>
100	150	with pipe Ø 110	AE10029000	<b>28,00</b>
100	200	closed	AE10039000	<b>20,00</b>
100	200	with pipe Ø 110	AE10049000	<b>28,00</b>
100	250	closed	AE10059000	<b>20,00</b>
100	250	with pipe Ø 110	AE10069000	<b>28,00</b>
150	195	Ø 110 universal	AE15009000	<b>28,00</b>
150	245	Ø 110 universal	AE15019000	<b>28,00</b>
200	245	Ø 160 universal	AE20009000	<b>31,00</b>
300	295	Ø 200 universal	AE30008000	<b>53,00</b>



Closed



with pipe



Universal

## STEPPED FALL 100/150

Type	For channel (H)	Article number	Retail price Eur/pcs.
100	H 150/200/250	AL10000102	<b>15,00</b>
150	H 195/245	AL15000102	<b>20,00</b>



## SEALANT

Type	Color	Capacity	Article number	Retail price Eur/pcs.
Sealant to connect elements from polyester concrete	grey	310 ml	PUP0000310	<b>15,00</b>

